



by Schneider Electric

Installation Guide Smart-UPS™ 750/1000/1500/2200/3000 VA 120/208/230 Vac Rack-Mount 2U

Safety Messages

SAVE THESE INSTRUCTIONS - This manual contains important instructions that should be followed during installation and maintenance of the Power Management Unit, Service Bypass Unit and batteries.

Read the instructions carefully and look at the equipment to become familiar with the device before trying to install, operate, service or maintain it. The following special messages may appear throughout this document or on the equipment to warn of potential hazards or to call attention to information that clarifies or simplifies a procedure.



The addition of this symbol to a Danger or Warning product safety label indicates that an electrical hazard exists that will result in personal injury if the instructions are not followed.



This is the safety alert symbol. It is used to alert you to potential personal injury hazards. Obey all safety messages that follow this symbol to avoid possible injury or death.

DANGER

DANGER indicates a hazardous situation which, if not avoided, will result in death or serious injury.

WARNING

WARNING indicates a hazardous situation which, if not avoided, could result in death or serious injury.

CAUTION

CAUTION indicates a hazardous situation which, if not avoided, could result in minor or moderate injury.

NOTICE

NOTICE is used to address practices not related to physical injury.

Product Handling Guidelines

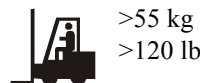

Safety and General Information

Inspect the package contents upon receipt. Notify the carrier and dealer if there is any damage.

Read the Safety Guide supplied with this unit before installing the UPS.

- Adhere to all national and local electrical codes.
- This UPS is intended for indoor use only.
- Do not operate this UPS in direct sunlight, in contact with fluids, or where there is excessive dust or humidity.
- Be sure the air vents on the UPS are not blocked. Allow adequate space for proper ventilation.
- The battery typically lasts for two to five years. Environmental factors impact battery life. Elevated ambient temperatures, poor quality utility power, and frequent short duration discharges will shorten battery life.
- Connect the UPS power cable directly to a wall outlet. Do not use surge protectors or extension cords.
- The equipment is heavy. Always practice safe lifting techniques adequate for the weight of the equipment.
- The batteries are heavy. Remove the batteries before installing the UPS and XLBP in a rack.
- Always install external battery packs (XLBPs) at the bottom in rack-mount or stack configurations. The UPS must be installed above the XLBPs.
- Always install peripheral equipment above the UPS in rack-mount or stack configurations.
- The UPS will recognize as many as 10 external battery packs connected to the UPS. However there is no limit to the number of XLBPs that can be used with the UPS.
- The model and serial numbers are located on a small, rear panel label. For some models, an additional label is located on the chassis under the front bezel.
- Always recycle used batteries.
- Recycle the package materials or save them for reuse.

FCC warning

This equipment has been tested and found to comply with the limits for a Class A digital device, pursuant to part 15 of the FCC Rules. These limits are designed to provide reasonable protection against harmful interference when the equipment is operated in a commercial environment. This equipment generates, uses, and can radiate radio frequency energy and, if not installed and used in accordance with the instruction manual, may cause harmful interference to radio communications. Operation of this equipment in a residential area is likely to cause harmful interference in which case the user will be required to correct the interference at his own expense.

Inventory

All models



(1)

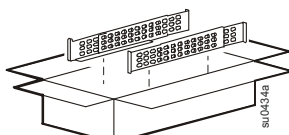

(1)

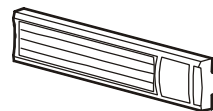

(1)

2200/3000 VA models

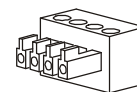

(1)

120/208/230 Vac models



(1)

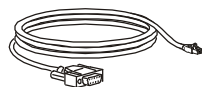

(1)

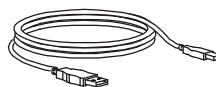

(1)

230 Vac models

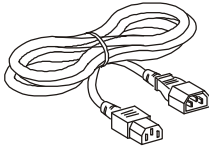

(2)

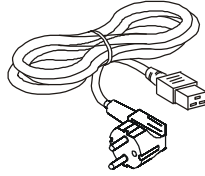

(1) 2200/3000 VA models

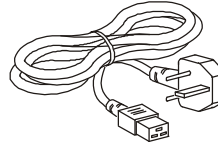

(1) 2200/3000 VA models

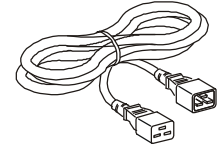

(1) 2200/3000 VA models

Installation

⚠ CAUTION

RISK OF DROPPED OR FALLING EQUIPMENT

- The equipment is heavy. Always practice safe lifting techniques adequate for the weight of the equipment.
- Remove the battery before installing the UPS in a rack.
- When installing equipment in a rack, always install the UPS at the bottom of the rack with the peripheral equipment above the UPS.
- The UPS should always be installed below peripheral equipment in stack or rack configurations.

Failure to follow these instructions can result in equipment damage and minor or moderate injury

⚠ CAUTION

RISK OF HYDROGEN SULPHIDE GAS AND EXCESSIVE SMOKE

- Replace the battery at least every 5 years.
- Replace the battery immediately when the UPS indicates battery replacement is necessary.
- Replace battery at the end of its service life.
- Replace batteries with the same number and type of batteries as originally installed in the equipment.
- Replace the battery immediately when the UPS indicates a battery overtemperature condition, or when there is evidence of electrolyte leakage. Power off the UPS, unplug it from the AC input, and disconnect the batteries. Do not operate the UPS until the batteries have been replaced.
- *Replace all battery modules (including the modules in External Battery Packs) which are older than one year, when installing additional battery packs or replacing the battery module(s).

Failure to follow these instructions could result in equipment damage and minor or moderate injury.

*Contact APC by Schneider Electric Worldwide Customer Support to determine the age of the installed battery modules.

750 VA models

1

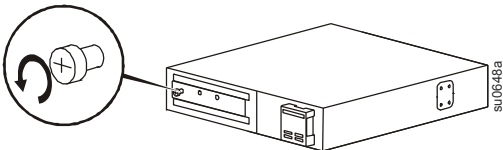

2

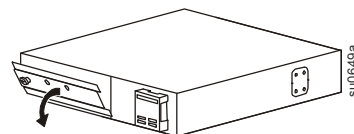

3

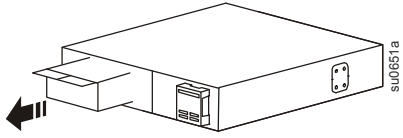

su0651a

4

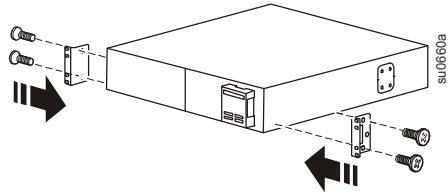

su0660a

5

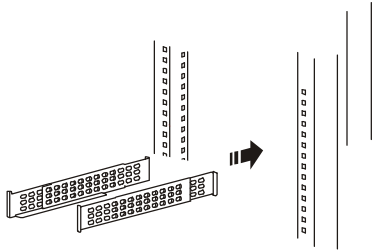

6

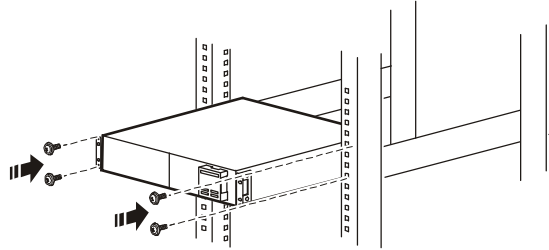

su0440a

su0469a

7

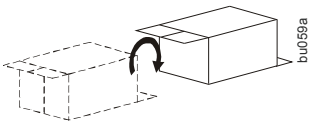

bu059a

8

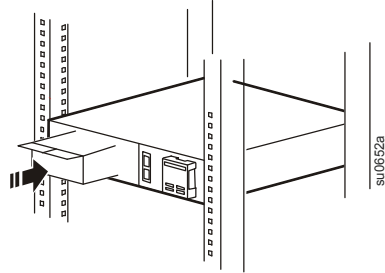

su0652a

9

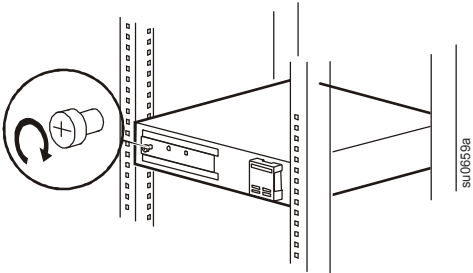

su0659a

10

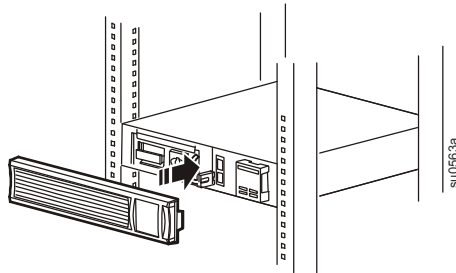

su0653a

1000/1500 VA models

1

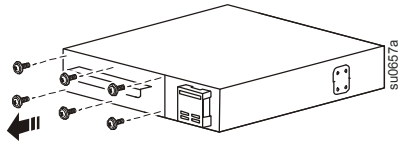

2

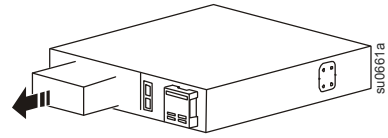

3

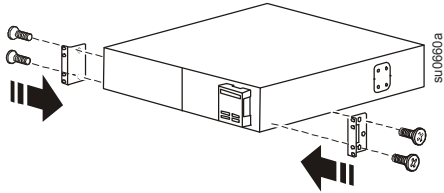

4

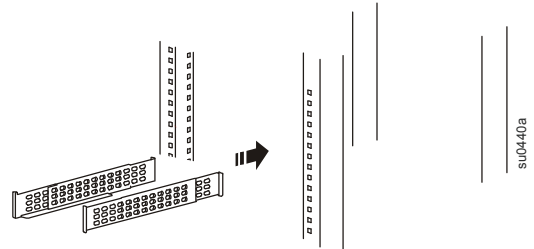

5

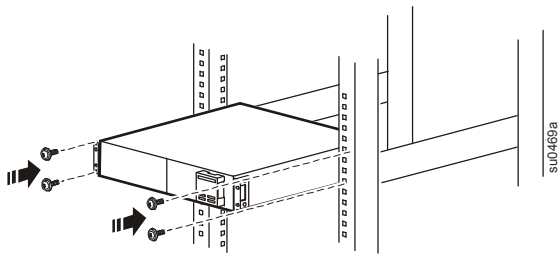

6

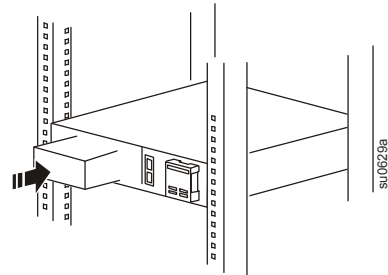

7

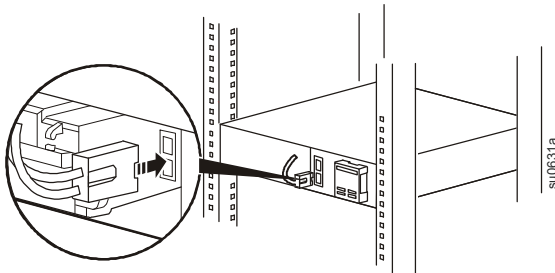

8

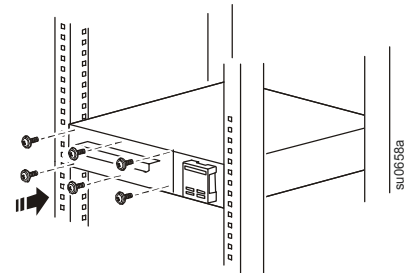

9

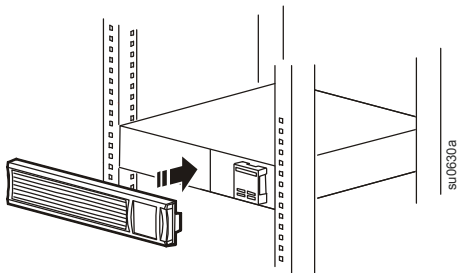

2200/3000 VA models

1

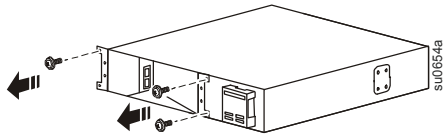

2

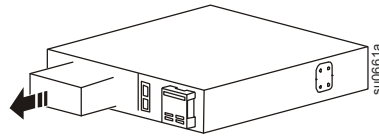

3

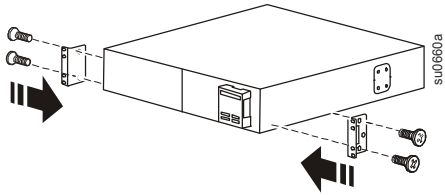

4

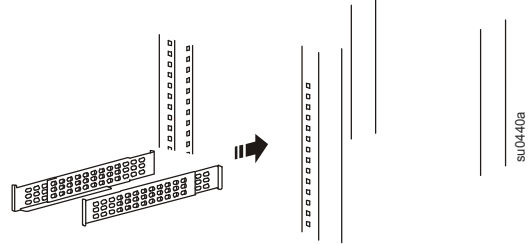

5

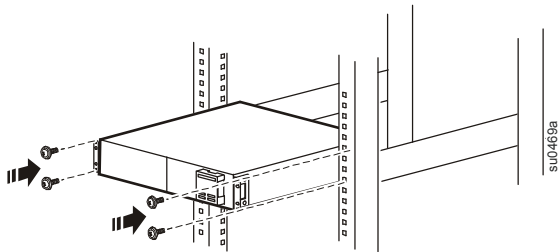

6

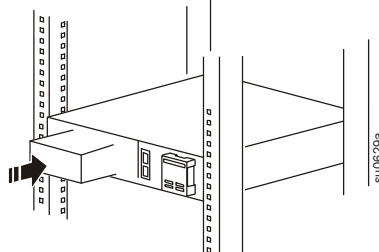

7

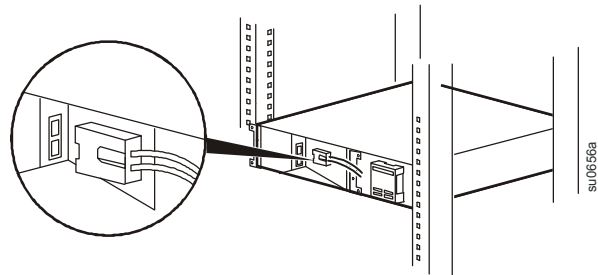

8

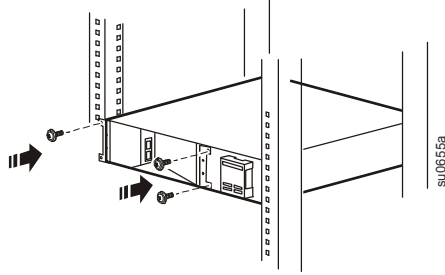

9

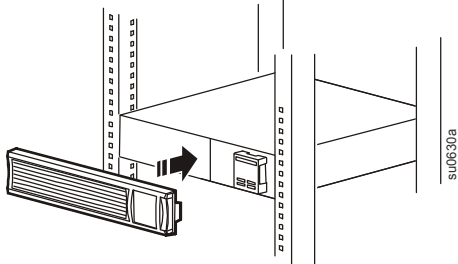

Overview and Start Up

Rear panel features

- ❶ SmartSlot for optional NMC accessory card
- ❷ UPS input
- ❸ Circuit breaker/Overload protection
- ❹ Controlled outlet group
- ❺ Chassis ground screw
- ❻ Outlets
- ❼ EPO connector
- ❽ USB port
- ❾ RJ45 connector - UPS monitoring serial port

750/1000 VA 120 Vac
1500 VA 100/120 Vac

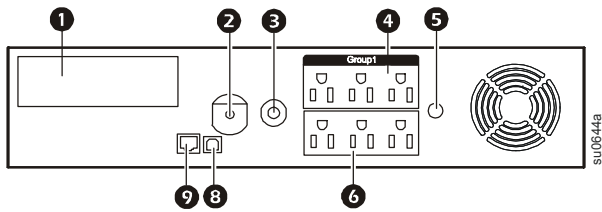

3000 VA 100/120 Vac

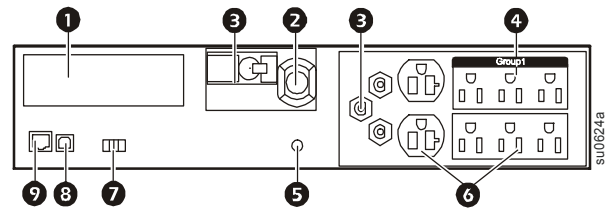

750/1000/1500 VA 230 Vac

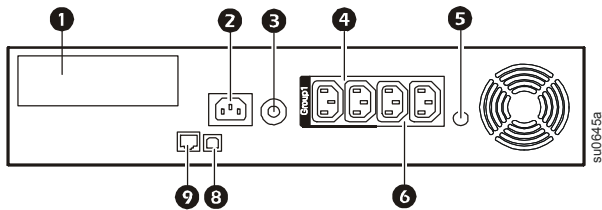

3000 VA 208 Vac

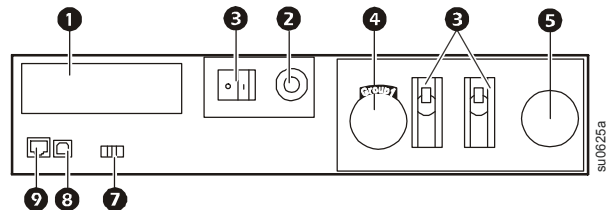

2200 VA 120 Vac

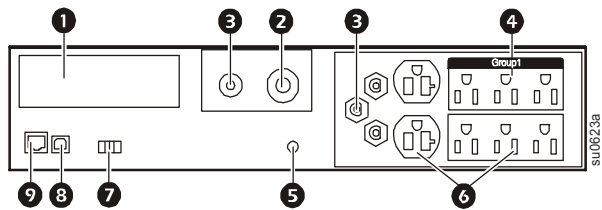

2200/3000 VA 230 Vac

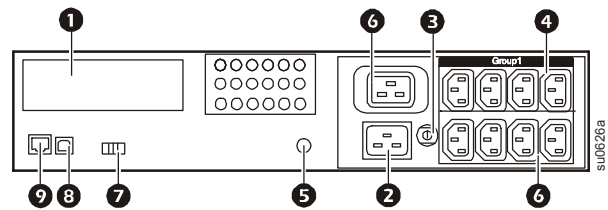

Electrical connections

⚠ CAUTION

RISK OF ELECTRIC SHOCK

- Adhere to all local and national electrical codes.
- Wiring must be performed by qualified electrician.
- Always connect the UPS to a grounded outlet.

Failure to follow these instructions can result in minor or moderate injury

Plug type and connector locations may vary.

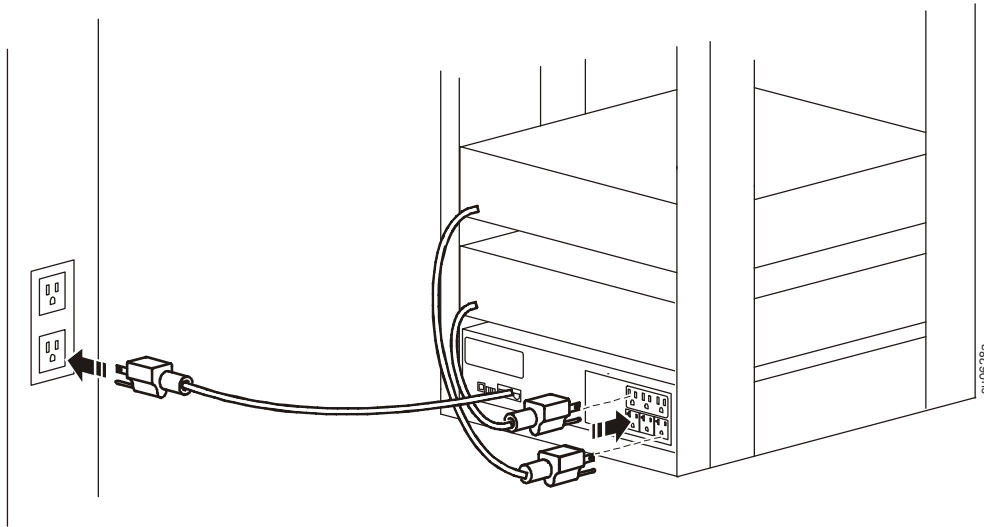

Display panel features

- 1 Online LED
- 2 UPS ON/OFF key
- 3 On Battery LED
- 4 Site Wiring Fault LED
- 5 Replace Battery LED
- 6 Display interface
- 7 UP/DOWN arrow keys
- 8 ENTER key
- 9 ESCAPE key

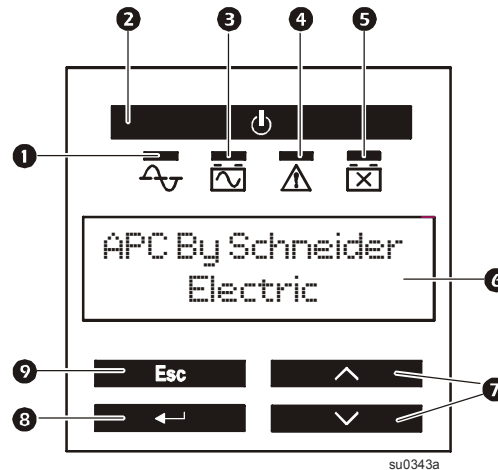

Controlled outlet groups

Some UPS models have one bank of outlets that can function as a controlled group. Use the display interface to configure the controlled outlet features, navigate to:

Main Menu > Control > Outlet1 Control.